

Installation instruction
Devidry™ Kit

Devidry™

Congratulations with your new DEVI floor heating system. DEVI is Europe's leading floor heating manufacturer with more than 45 years of experience. We are confident that you will be satisfied with your new system. DEVI brings you optimum comfort with the luxury and comfort of a warm floor as well as a pleasant room temperature. Floor heating is the most comfortable type of heating because it is based on the fact that warmth travels upwards; pleasant warmth for your feet, body and head.

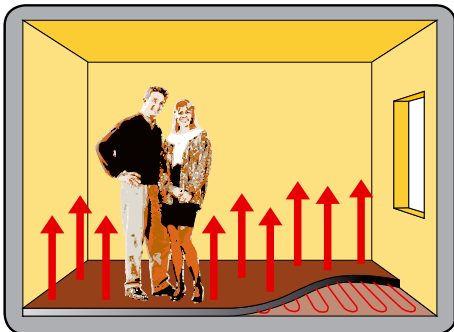
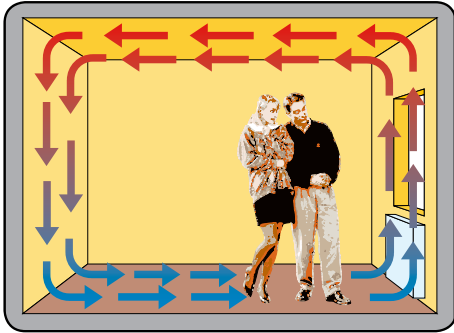

General information

The Devidry™ floor heating system consists of a foam/carpet heating element with heating elements inside. The system must always be controlled with the Devidry™ Kit (controller and current device – sold separately) as it is part of the safety and overheating protections system. The Devidry™ floor heating system has been developed to the dry application area for underfloor heating. It is applicable for wooden and concrete floor constructions with the two output ranges 55W/m² and 100W/m². Your Devidry™ floor heating system complies with the standard for removable floors EN/IEC 60335-1 and EN/IEC 60335-2-106, which specifies the maximum output for the following floor constructions:

Wooden floor constructions:
Only 55 W/m²
Concrete floor constructions:
55 W/m² or 100 W/m²

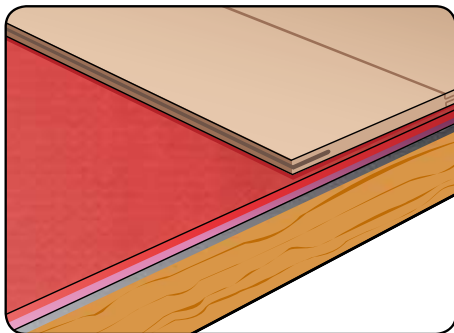

*Flooring Devidry™
Wooden floor construction*

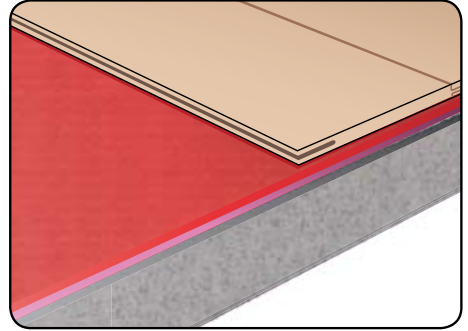

*Flooring Devidry™
Concrete floor construction*

The Devidry™ floor heating system can be used under wooden floors, parquet and laminate (and thin carpets). Please check the specifications with your supplier of these products. The insulation value of the floor covering should not exceed 0,1m² K/W. The Devidry™ floor heating system is for indoor applications in dry rooms only and must always be installed with the Devidry™ Kit. If the system is installed under carpets we recommend to full tape the elements together with duct tape (not supplied in the kit). As with any other underfloor heating system, it will be most effective if the underfloor is well insulated. The following directions will guide you step-by-step through the installation process. Please read the directions and the safety precautions before you start the installation process.

Product overview

The Devidry™ Kit consists of the Devidry™ C (controller), the Devidry™ CD (current device), the Devidry™ Connection Tool and aluminium tape to fasten the floor sensor to the floor with.

Other products in the Devidry™ product range are:

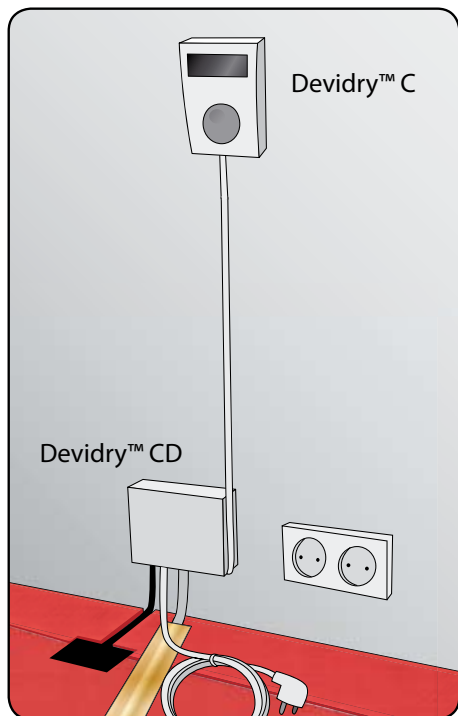

Devidry™ C

Devidry™ CD

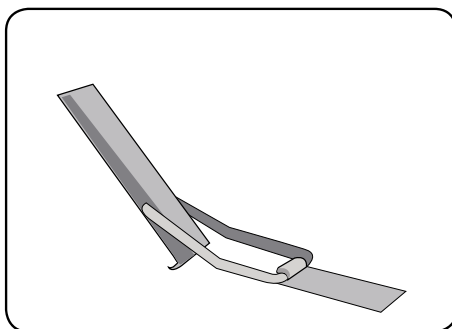

Devidry™ Connection Tool

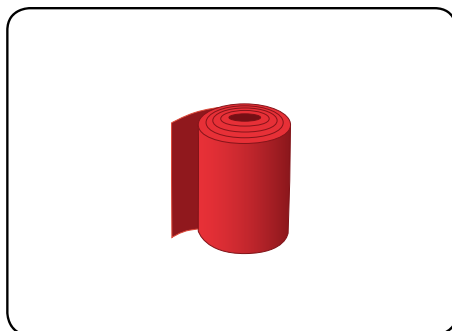

Devidry™ FM

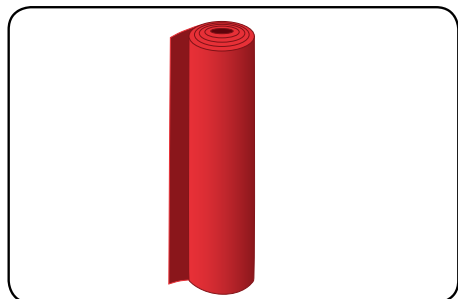

Devidry™ Element

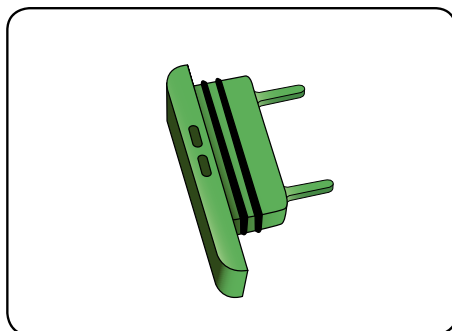

Devidry™ End Stop

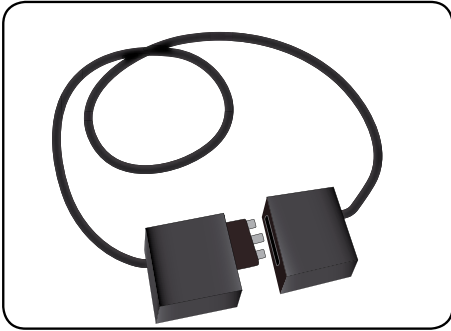

Devidry™ X

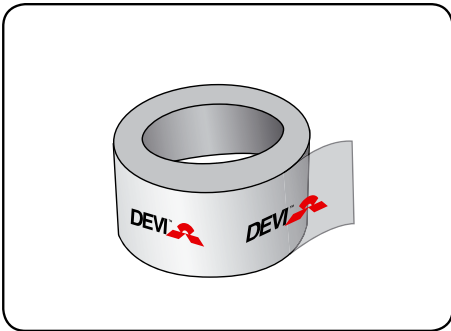

Devidry™ Tape

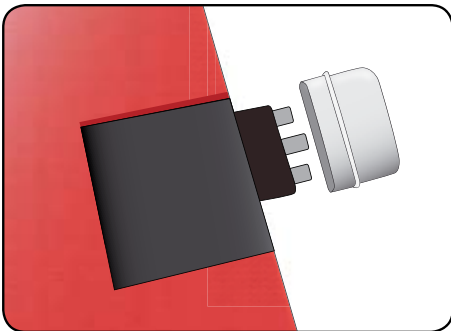

Devidry™ Protection Cap

Products supplied for <u>wooden</u> floor constructions	
Devidry™ Name	Description
Devidry™ 55	Devidry™ Element
Devidry™ Kit 55	Devidry™ Kit

Products supplied for <u>concrete</u> floor constructions	
Devidry™ Name	Description
Devidry™ 55	Devidry™ Element
Devidry™ Kit 55	Devidry™ Kit
or	
Devidry™ 100	Devidry™ Element
Devidry™ Kit 100	Devidry™ Kit

Accessories	
Devidry™ Name	Description
Devidry™ X-25	Devidry™ Extension Cord, 25 cm
Devidry™ X-100	Devidry™ Extension Cord, 100 cm
Devidry™ X-200	Devidry™ Extension Cord, 200 cm
Devidry™ FM-1	Devidry™ Filler Material, 1 m ²
Devidry™ FM-2	Devidry™ Filler Material, 2 m ²
Devidry™ FM-4	Devidry™ Filler Material, 4 m ²
Devidry™ Tape	Devidry™ Duct Tape

Technical Details









Installation in accordance with the national regulation and wiring rules for installation only.

Technical details of Devidry™ Kit	
Set point Range	5°C- 30/35°(*)
Temp. indication accuracy	±1,5°C max.
Hysteresis	1,2°C
Temperature display and setting unit	0,5 °C /STEP
Operating Temperature	5°C ~ 45°C
Storage Temperature	-20°C ~ 55°C
Mains voltage	230 V 50 Hz
Max. Amps per Devidry™ Kit	10 Amps
Output	2300 W
Humidity	5% ~ 95% RH (non condensing)

(*) 30°C for wooden floor constructions and 35°C for concrete floor constructions

Maximum heated surface per Devidry Kit (Max. 10A)	
Product	Max. heated surface
Devidry™ 55	42 m ²
Devidry™ 100	23 m ²

Signature explanation

	<p>This side up</p>
	<p>Heating element must only be installed on top of concrete floor constructions (never on wooden floor consr imbedded in concrete) truction, never imbedded in concrete)</p>
	<p>The Devidry™ element may be cut here to fit the actual area, as there are no electrical parts in this area</p>
	<p>The Devidry™ element cannot be cut here as there are electrical parts in this area</p>
	<p>For indoor use only</p>
	<p>Read the instruction manual before installation</p>
	<p>Double insulated</p>
	<p>Devidry™ is certified by KEMA</p>
	<p>DEVI declares that Devidry™ is tested according to the standard for removable floors:</p> <ul style="list-style-type: none"> • EN/IEC 60335-1 Household and similar electrical appliances – Safety – Part 1: General requirements and • EN/IEC 60335-2-106 Household and similar electrical appliances – Safety – Part 2-106 with parti for heated carpets and heating units for room heating installed under removable floor coverings cular requirements

Mounting the Devidry™ Kit

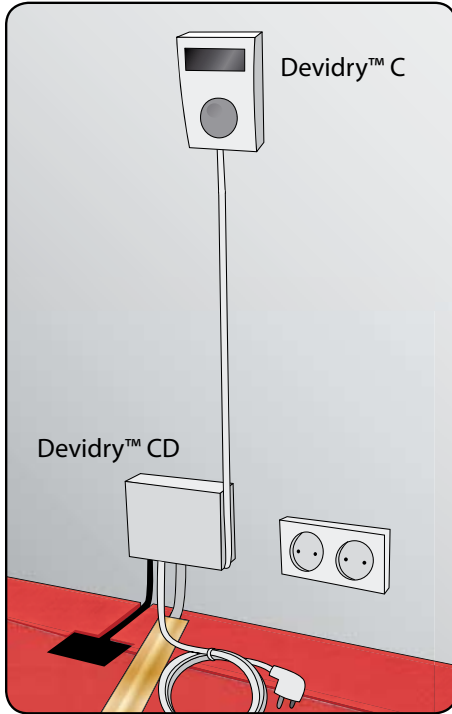

Devidry™ Kit

1 Mount the Devidry™ CD

The Devidry™ CD should be mounted on the wall 10 - 30 cm above the floor

2 Install the floor sensor

The floor sensor is installed by clicking the connector into the port in the Devidry™ CD. The sensor must be placed in a position where at least 30 cm of the sensor is lying on the Devidry™ **heated** element. The end of the sensor should be placed right between two cables in the element as shown in the figure.

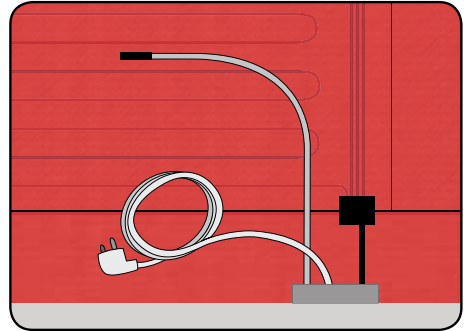

3 Install the output cord

Cut a piece of material from the filler material to make room for the output cord between the Devidry™ Kit and the Devidry™ element. Make sure not to fold and/or squeeze the cord between the kit and the floor heating element but make room for the cord in the filler material. Minimum bending diameter is 5 cm.

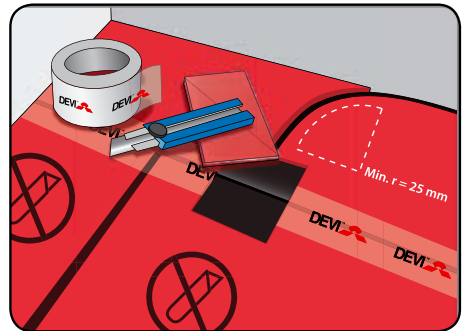

4 Mount the Devidry™ C

The Devidry™ controller **C** should be mounted 150 cm above the floor and plug the control system into the wall socket.

5 Set the temperature on the Devidry™ C

Set the temperature at maximum temperatures (30° Celsius for wooden floors and 35° Celsius for concrete floor constructions). After a short while you will notice the Devidry™ floor heating elements are warming up.

Max. set point temperature of the thermostat is:

- 30°C for wooden floor constructions
- 35°C for concrete floor constructions

If the floor heating elements are not warming up to the same temperature the plug-in connections should be checked once again. Remember to first unplug the Devidry™ system from the mains.

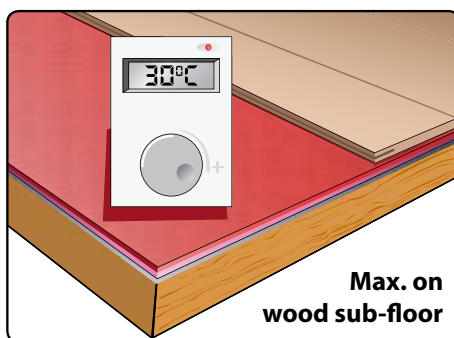
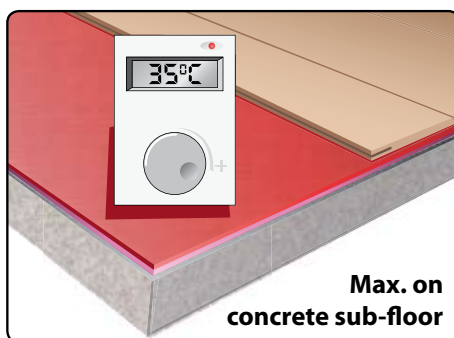

6 How to operate the Devidry™ Controller

Power on

- When power is ON the power LED < Power > is ON and the present temperature is displayed on a window.

How to check the set temperature

- Turn the knob to see the previously set temperature appearing in the window.

How to set the temperature on LCD window

- Turn the knob to the left or to the right to set the desired temperature.
- The present temperature will be displayed in a few seconds on LCD and the setting is done.

How to frost protect furniture and equipment during winter

- Press <Frost protection> button to maintain the room temperature constantly at 5°C

How to set the RESERVATION

- This function is used to reserve the operating time.
- Press the <timer> button, then <12> is displayed on a window.

Set the desired time (1~24hours) by turning the knob. (Ex.) If you set the time as <01>, the Devidry™ Element will start operating after 1 hour.

- The present temperature and the symbol <timer> are displayed. Then setting is over. If you want to terminate the <RESERVATION> function, press <timer> symbol once more. The <timer> symbol will disappear in the LCD window.

If the safety circuit of the Devidry™ CD is activated

- If the system stops working it might be because the safety circuit of the

Devidry™ CD is activated. In that case the whole Devidry™ system will stop working. The safety circuit of the Devidry™ CD is activated and must be replaced if the Devidry™ element is damaged or if too much power is connected to the system (max. 10 A).

- If it is obvious that a Devidry™ element has been damaged or too much power has been connected to the system, you can solve the problem by removing the damaged element or remove the excess elements.
- A new Devidry™ CD can be bought as accessory. Remember that the problem should be solved before a new Devidry™ CD is installed. Otherwise it will be activated again.
- All other repairs should be done by an authorised electrician.

Dimensions

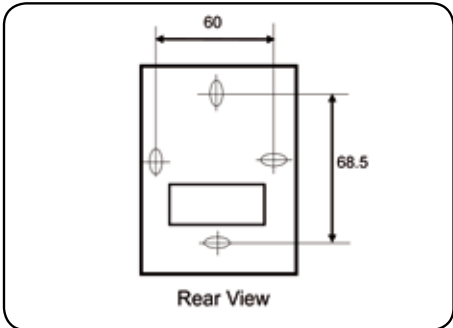
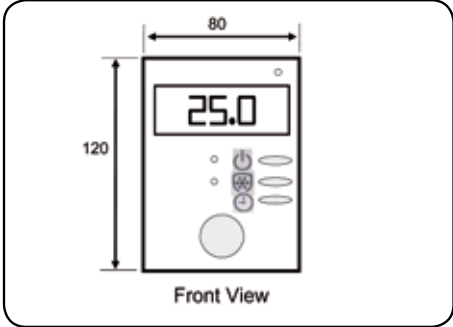

Unit = mm

Safty precautions

- Use the floor heating element for the purposes described in the directions only.
- Devidry™ must always be installed with the Devidry™ Kit
- Mount and connect the Devidry™ Kit to the mains following the correct installation instructions supplied with the Kit. The Devidry™ Kit is sold separately.
- The Devidry™ floor heating system is to be supplied through a residual current device having a rated residual operating current not exceeding 30 mA.
- All the used Devidry™ elements must have the same area output.
- The Devidry™ elements are not to be installed on irregular surfaces.
- Do not fold or sharply bend the floor heating elements.
- In order to avoid a fire hazard, the Devidry™ 100 is to be installed only above a floor of concrete or similar material. Devidry™ 55 can be installed on either concrete or wooden floors.
- The controller Devidry™ C100 must only be used with installations on concrete floors and Devidry™ C55 can be used with both floor constructions.
- Devidry™ heating element must be separated from other heat sources.
- The Devidry™ heating element must not be installed at ambient temperatures below 5°C.
- The Devidry™ floor heating system is only for indoor use.
- Do not install or use the floor heating system after one or more components have been damaged.
- Do not allow home repairs under any circumstances. Repairs must be carried out by qualified electricians. Faulty repairs may cause personal injury or damage to property.
- Do not use the floor heating in combination with parts that are not recommended, installed or supplied by DEVI.
- Use original parts of the Devidry™ floor heating system only. The warranty for the entire system and for the separate parts becomes null and void if parts from other manufactures have been used.
- Make sure that no hot spots develop when using the floor heating system. Avoid hot spots by ensuring that the heat from the floor heating is homogeneously released to the area you wish to heat. Do not install the floor heating element under permanent or built-in cupboards (full covering furniture).
- Do not use the Devidry™ floor heating system if the system is wet.
- Warning label should be filled out and placed next to the distribution switchboard.
- The Devidry™ floor heating system is only to be used with the Devidry™ extension cords (The Devidry™ X). Do never cut the extension cords or the output cords.
- Do not buckle the supply cord and the extension cords; do not have them run across hot and/or sharp objects.
- Unroll the cords entirely to prevent the cords from over heating.
- Remove the plug from the wall socket outlet if work is carried out at or near the floor heating system when fluids or sharp objects are being used.

- Do not pull the cord or the floor heating to undo a plug-in connection. Always hold the plug and take the unit apart with the connection tool.
- If the extension or output cord is damaged, it must be replaced by the manufacturer, its service agent or similar persons in order to avoid a hazard.
- Connect the floor heating to alternating current 230 Volt and 50 Hz only.
- Do not allow needles, sharp objects, liquids and/or other electricity-conducting objects/fluids to make contact with the floor heating.
- The printed side of the heating element must be visible when rolling out the element showing the symbol: THIS SIDE UP ↑↑
- Save the manual together with the warranty papers for further use – or if you want to take the Devidry floor heating system with you at a later state.

Layout paper

Please draw the room on the page below and position the heating mats that you are installing (for future reference)

These products are installed in Room _____

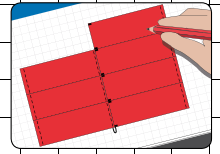
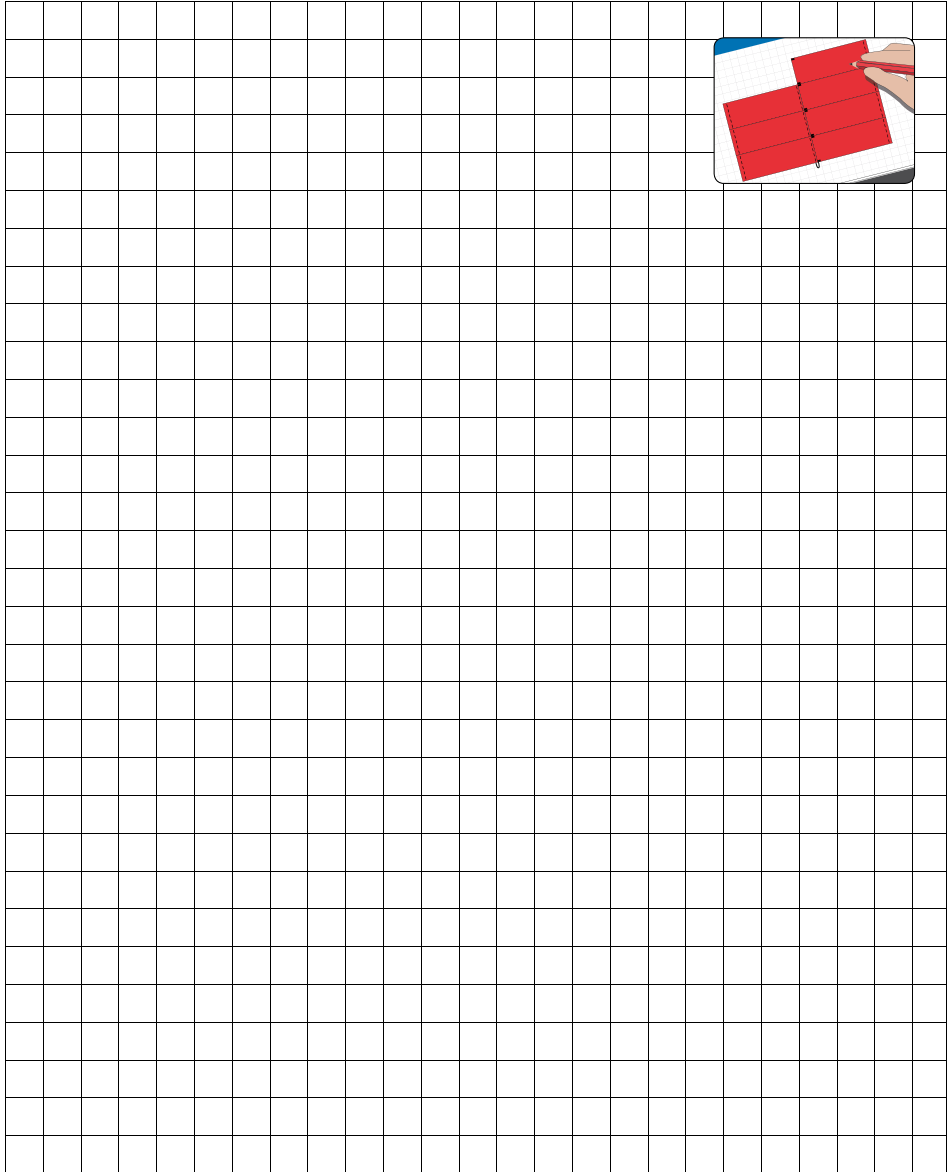

The 2 Year DEVI Warranty:

You have purchased a DEVI heating system which we are sure will serve to improve the comfort and economy of your application.

DEVI provides superior electrical heating solutions for total climate control in and around homes and buildings. DEVI offers a complete product program with Deviflex™ heating cables or Devimat™ heating mats, Devireg™ thermostats, Devidry™ heating systems, Devifast™ fixing strips and Devi Self-limiting heating cables combined with additional products completing the product program.

This 2 year warranty applies to all DEVI products.

Should you, against all expectations, experience a problem with your DEVI product, you will find that DEVI offers a 2 year warranty from the date of purchase on the following conditions:

During the warranty period DEVI shall offer a new comparable product or repair the product in case the product is found to be faulty by reason of defective design, materials or workmanship. Repair or replacement shall be carried out at DEVI's discretion. DEVI shall not be liable for any consequential or incidental damages including, but not limited to, damages to property or extra utility expenses.

This warranty shall only be valid on production of proof of purchase and must be submitted to the installer or seller without undue delay.

An extension of the warranty period following repairs undertaken under warranty cannot be granted.

The DEVI Warranty shall not cover any damage caused by incorrect conditions of use, incorrect installation or if installation has been carried out by non-authorized electricians. All work will be invoiced in full if DEVI is required to inspect or repair faults that have arisen as a result of any of the above.

The DEVI Warranty shall not extend to equipment which has not been paid in full.

DEVI will, at all times, provide a rapid and effective response to all complaints and inquiries from our customers.

The warranty explicitly excludes all claims exceeding the above conditions.

2 YEAR WARRANTY

Warranty Certificate

The DEVI Warranty certificate is granted to

Name

Address

City

Country

Telephone

Attention:

*The Warranty Certificate must be completed correctly for the Warranty to be valid.
Please read the Warranty conditions on the previous page.*

Type of product

Material number

Supplier Stamp

08080351
Version - 01

DEVI A/S
Ulvehavevej 61
DK-7100 Vejle
Tel: +45 7642 4700
Fax: +45 7642 4701
www.devi.com